

Surge-Trap® Type 1 STLC Series SPD

POWER LINE SPD - NEMA UL CSA TYPE 1



It is estimated that the average home has \$15,000 worth of equipment that can be damaged by electrical surges. Mersen's Surge-Trap® STLC surge protective device adds a critical layer of surge protection for your entire home. From your family room to your office, and your kitchen, your entire electrical system is protected. This simple whole house solution is installed directly in your electrical panel and has flexibility to fit in a variety of different load center manufacturers and models. The STLC Series is designed with Mersen's TPMOV® to ensure superior safety and reliability, it is a UL 1449 4th Edition Type 1 SPD, and satisfies the new 2020 NEC Article 230.67 requirement for surge protection for residential dwellings.

Technical Data Overview	
Part Number	STLC240S025
UL SPD Type	Type 1
Nominal Discharge Current Rating (In)	10kA
Surge Capacity (per phase and per mode)	25kA
Short-Circuit Current Rating (SCCR)	10kA *tested to 100kA
Maximum Continuous Operating Voltage (MCOV, U _c)	L-N: 150; L-L: 300
Voltage Protection Rating (VPR) (UL 1449, 6kV, 3kA)	L-N: 600; L-L: 1000
Ambient Temperature Rating	-20 ... 65°C

FEATURES/BENEFITS

- Designed with industry leading Mersen TPMOV® Technology
- Installs directly into load center bus bar, utilizing any (two) open adjacent breaker slots
- Versatility: fits into most residential load centers with 1" spacings (see page 2 for compatibility list)
- LED status indicator (ON = Good, OFF = Replace)
- 2 Modes of Protection (L-N, L-L)
- 3-year manufacturer's warranty, plus up to \$25k connected equipment warranty (see warranty document for details)

APPLICATIONS

- 120/240VAC residential load centers

APPROVALS/STANDARDS

- ANSI/UL 1449 4th Edition, Type 1 SPD, File E517916
- RoHS Compliant



© 2021 Mersen. All rights reserved. Mersen reserves the right to change, update, or correct, without notice, any information contained in this datasheet.

DIMENSIONS

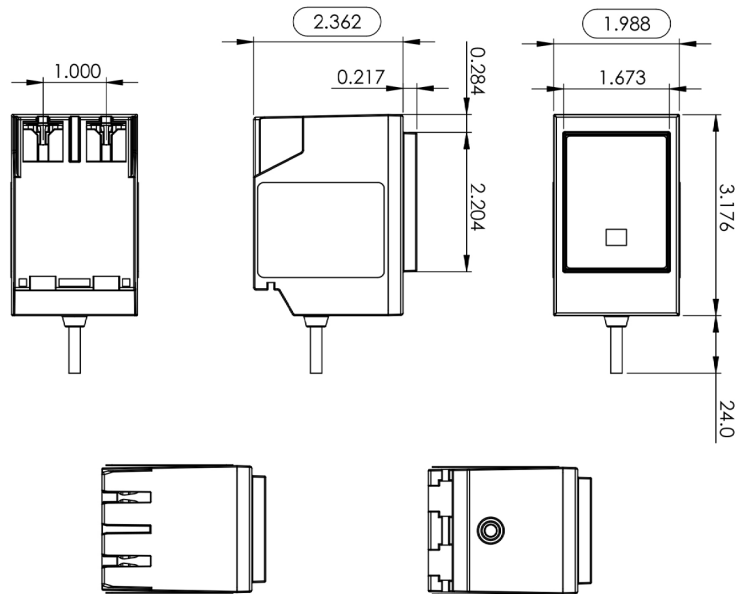

COMPATIBILITY CHART

Brand	Load Center	Circuit Breaker Type
Eaton	BR Series (prefix 1BR or B in the catalog number)	BR215 ... BR250, BR, 2P, 120/240 V AC, 15A ... 50A
Siemens Industry, Inc.	PL Series (prefix P or PW in the catalog number)	Q215 ... Q250, QP, 2P, 120/240VAC, 15A ... 50A
	ES Series (prefix S or SW in the catalog number)	Q215 ... Q250, QP, 2P, 120/240VAC, 15A ... 50A
	EQ Series (prefix E in the catalog number)	Q215 ... Q250, QP, 2P, 120/240VAC, 15A ... 50A
Murray/Siemens Industry, Inc.	LC Series (prefix LC or LW in the catalog number)	MP215 ... MP250, MP, 2P, 120/240VAC, 15A ... 50A
ABB / General Electric	Powermark Gold series (prefix TL, TM or TP in the catalog number)	THQL215 ... THQL250, 2P, 120/240 V AC, 15 ... 50 A
Schneider Electric USA Inc./Square D Co.	Homeline series (prefix HOM in the catalog number)	HOM215 ... HOM250, 2P, 120/ 240 V AC, 15 ... 50 A

© 2021 Mersen. All rights reserved. Mersen reserves the right to change, update, or correct, without notice, any information contained in this datasheet.